

These installation instructions are for the UNICLIC (ANGLE/ANGLE) locking system only.



Attention! Read Before Installing!

FOR BEST VISUAL REPRESENTATION OF YOUR FLOOR

This flooring replicates the look of a natural product which has natural variations in color and texture. For best visual effect, shuffle planks from several cartons and do not install similar boards next to one another.

SUBFLOOR PREPARATION

Check that the doors can still open and close after the floor has been installed (minimum 3/8 inch).

Concrete Subfloor

The moisture content of the concrete must be less than 5 lb/24 hr per 1000 sq ft (ASTM F1869) or <80% with an in situ probe (ASTM F2170). Always use underlayment and a minimum 6-mil poly moisture barrier if a moisture barrier is not attached to the underlayment.

New Construction:

- A new concrete floor must dry at least 1 week per 3/8-inch thickness up to 1-1/2 inches. Thicknesses over 1-1/2 inches require twice as much drying time. For example, a 2-1/2-inch concrete subfloor must dry for at least 8 weeks.

Renovation:

- Remove any damp-porous floor covering (carpet, needle felt, etc.) first.
- Damp-sealed floor covering (PVC, linoleum, VCT, etc.) does not have to be removed.

Wooden Subfloor

- Remove any existing damp-porous floor covering first.
- Make sure the sub floor is stable. Nail down any loose areas and apply a leveling layer if necessary.
- Install the HF Design planks crosswise to the direction of the existing subfloor.
- For installations over a crawl space, the soil in the crawl space must be covered by a 6-mil non-recycled polyethylene film with seams overlapping at least 8 inches. In addition, vents should be located throughout the foundation. They must provide good cross ventilation and no dead air space. There must be minimum vent openings equal to 1.5% of the square footage within the crawl space. For example, 100 sq ft of crawl space must have at least 1.5 sq ft of open vents.
- The moisture content of the wood may not exceed 12%.

IMPORTANT NOTICE

All Laminate based products, even those specifically designed to have increased resistance to moisture, are hygroscopic (they will react to the moisture in the environment) and as a result will expand or contract accordingly. All sources of under floor moisture must be rectified prior to the installation of the floor. Any construction dampness must be completely dry. Although this product has been designed with bathroom installation in mind it is water resistant and not waterproof and excessive wetting is to be avoided and water spillages dried immediately. At no time should standing water be left on the floor. It is important that you check each plank for any manufacturing defects. Any faults must be reported back to the store of purchase for an immediate refund or replacement prior to the flooring being installed.

Calculate the room surface prior to installation and plan an extra 10% of flooring for waste.

Keep the boards in room temperature for at least 48 hours in unopened package before you start the installation to acclimate floors. In all cases, job site temperature should be at least 60°F and no greater than 85°F and the relative humidity should be maintained between 30% - 60%. The temperature and humidity must be controlled and maintained within the ranges described above for the life of the flooring. After installation the optimal temperature should be kept at 70°F.

Inspect your subfloor before you begin. It must be clean, dry (max. 2.5% moisture content - CM method) and level to 5mm (3/16") within a 3 meters (10 foot) span.

With a floating floor you must always ensure you leave a 3/8" gap between walls and fixtures such as pipes and pillars, stairs, etc. Tip: When installing around pipes, drill the holes 20mm (3/4") larger than the diameter of the pipes.

A vapor barrier is strongly recommended to be installed over concrete substrates. In the case installation is done over a wood substrate on or below grade a vapor barrier must be installed if there is not a vapor barrier existing in a well-ventilated crawl space. A minimum 0.15mm (6 mil) plastic poly sheeting should be used as a moisture barrier. Underlayments thicker than 3mm (2/16") are not advised. (Note: some collections may have a pad factory pre-attached to the back of planks, so no additional pad is needed).

Decide the installation direction. It is recommended to install the length direction of the planks parallel to the main light direction. Measure the area to be installed: The board width of the last row shall not be less than 50mm (2"). If so, adjust the width of the first row to be installed. When measuring, take the free gap requirement of about 12mm (1/2") of the floor perimeter into account. In narrow hallways, install the floor parallel to the length ways. Inspect your laminate flooring. No claims on surface defects will be accepted after installation.

Cabinets of kitchen islands should be installed prior to the laminate flooring.

TOOLS AND SUPPLIES REQUIRED

Foam Underlay (if not pre-attached)

- Spacers
- Saw
- Adhesive Tape
- 4mil (or thicker) polyurethane vapor barrier for crawl space and concrete floor installations.
- Rubber Mallet
- Ruler
- Pencil
- Tape Measure
- Utility Knife
- Constructions Adhesive

ALL AREAS

It is important to seal any cut planks to ensure superior and warranted performance. When a flooring plank is cut to fit (either end cuts or side cuts), a sealant is always required around the perimeter of the installation.

Once the flooring installation is completed, a general Silicone based sealant should be applied around the perimeter (in the expansion space at walls). This should also include any other areas such as islands, doorways, columns, etc. where the laminate flooring planks have been cut to fit.

Branded and generic Silicone tubes are available and any local home center or hardware location.

INSTALLATION

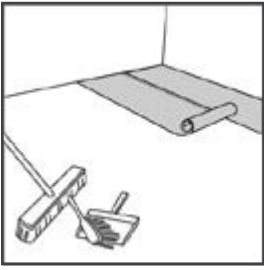

Cleaning and Underlay: After thoroughly cleaning the subfloor, you should install a foam underlay (unless your product has a pre-attached pad). Run the foam underlay in the same direction as the flooring planks. The underlay should be butted side-by-side with no overlap. Tape seams together. If you are installing over a concrete subfloor, a 6-mil poly (plastic sheeting) is recommended to be installed under the foam underlay. (Many foam underlays already have this plastic sheeting pre-attached).

TWO DIFFERENT WAYS TO INSTALL THE PLANKS

Method 1: Angle-In Installation Method

Position the panel to be installed at an angle of 20°-30° to the panel already installed. Move the panel gently up and down and at the same time exert forward pressure. The panels will automatically click into place. You can either insert the tongue into the groove, or the groove onto the tongue. The tongue in groove method is the most common and the easiest way.



Method 2: Flat installation Method

You can also tap the panels into each other without lifting. For this method you must use the special tapping block. The planks should not be joined with a single tap and the tapping block should set flat on the floor. To avoid damaging the panels you must tap them together gradually. See diagram 2 a-b. Use this method only in cases where you are unable to use the Angle-In method (see below). The rest of your floor should be installed using the Angle In method.



Cutting the Plank

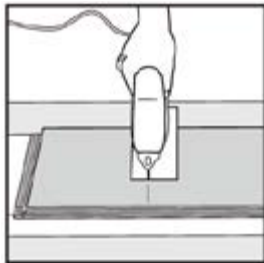

If cutting with a jig saw, the laminate surface should be turned down. If cutting with a hand saw, the laminate surface should be face up.

Planning Your Layout

It is very important to plan your layout to avoid an unbalanced installation with narrow plank widths at the walls. Lay the long dimension of the planks parallel to the long dimensions of the room. Draw a line with a chalk lengthwise along the middle of the room. Do a dry layout of planks from the center line to the wall running parallel to the long direction of the planks to determine the width of the last row of planks see the diagram to the right.

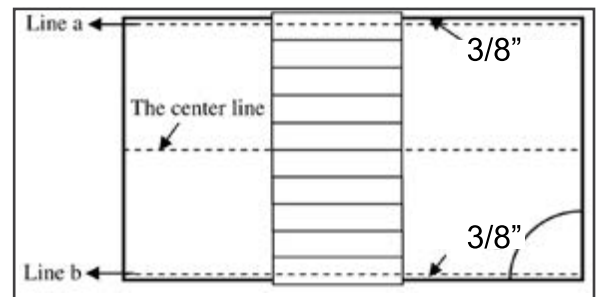

- Reserve a 3/8" expansion gap between the line and / or line b to the walls. Avoid having less than a half plank width at the line and / or line.
- Measure the width of the room at the front, middle and back and divide the widths of each measurement by the width of a plank. If the remainder is less than half the plank width, then the planks on your starter row should be narrowed to make the last row approximately half the plank. The width of the last row of planks should be approximately the same width as the first row of planks.

Note: This may also be figured out by laying down loose planks across the width of the room without securing them to each other and making the necessary adjustments.

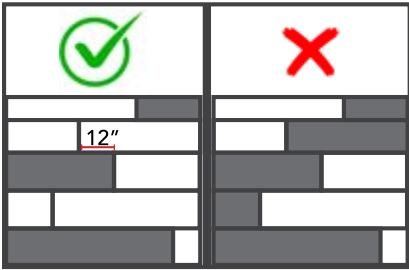

During installation, make sure that you mix the floor panels (and floor boxes) sufficiently so that there are not too many identical, lighter or darker planks next to each other. To obtain the best visual effect, it is best to install the panels in the direction of the longest wall and/or parallel to the incidence of light. Ensure that the end joints of the panels in 2 successive rows are never in line, they should be staggered by at least 12 inches. For a natural look and better mechanical strength, we do not recommend an installation of the planks in a pattern but rather at random formation.

TRANSITIONS

When installing next to other types of flooring use a transitions strip/molding. Installations of carpet, tiles, metal strips and other transition moldings should not push fully into the flooring and should allow for some slight movement wherever practical.

Large rooms must have expansion joints every 40 feet width-wise to the planks and every 40-feet length-wise. An expansion joint is recommended between different rooms (e.g. under the door). Expansion joints can be finished by means of a molding that is attached to the subfloor.

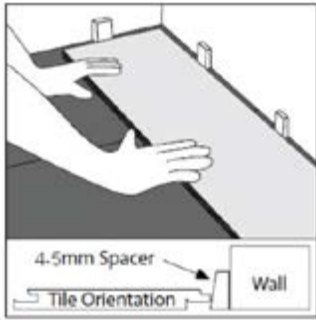

Step 1
Laying first plank in corner of room with tongue side facing wall using 3/8" spaces

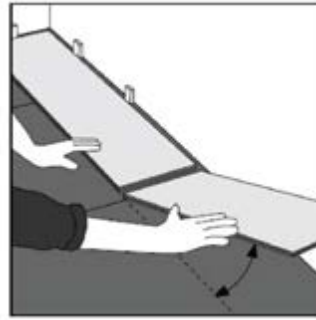

Step 2
Fitting of second plank

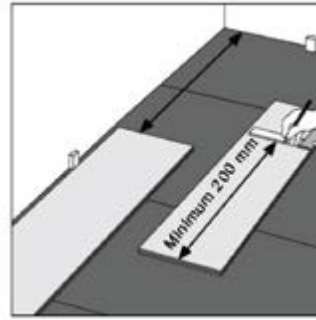

Step 3
Cutting and fitting of final plank in first row

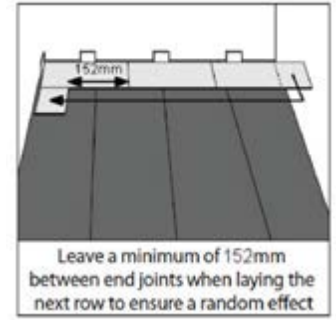

Step 4
Use of offcut from previous row (optimal)
Leave a minimum of 152mm between end joints when laying the next row to ensure a random effect

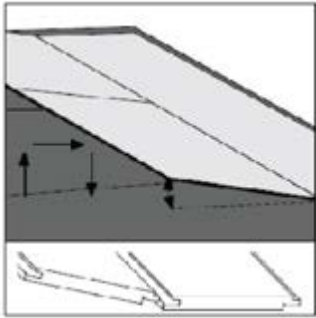

Step 5
Fitting of additional planks in second row

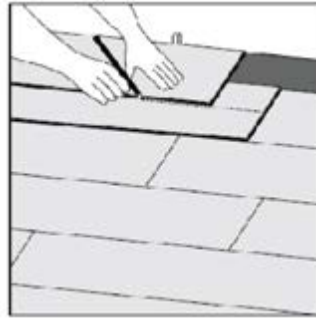

Step 6
Measure and cut final row of planks allowing for 3/8" expansion gap

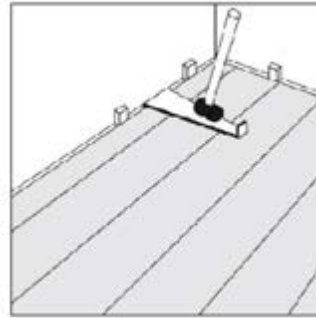

Step 7
Pull bar and rubber mallet can be used for final row of planks, ensuring a 3/8" expansion gap

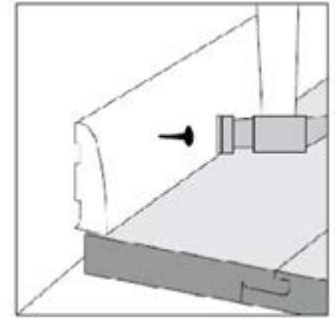

Step 8
Refitting of skirting board with hidden 3/8" expansion gap

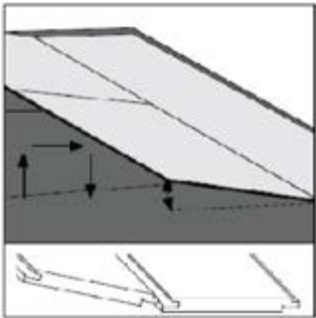

Step 9
Fixing edge trim to wall

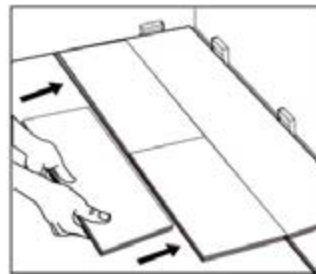

HELPFUL HINT

When installing each new row, take a full loose plank and use the long side to tap against the prior row to ensure no gapping.

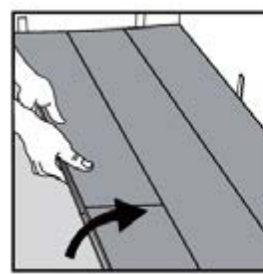

DISASSEMBLING

Separate the whole row by lifting it up delicately at an angle. To separate the planks, leave them flat on the ground and slide them apart.



Installation in Wet Areas (i.e. Bathroom, Kitchen, Mud Room, Laundry Room)

Since prolonged water exposure could damage your laminate flooring, the following installation recommendations should be closely followed to validate your residential water warranty. Wet areas would include, but are not limited to: bathrooms, powder rooms, kitchens, mud rooms, foyers, and laundry rooms. Neither flooring planks nor accessories are recommended for applications with extreme humidity. The water warranty excludes all products thinner than 3/8" and does not apply to beveled edge products when used in bathrooms. An expansion area of 3/8" must be provided around all vertical obstructions including walls, permanent cabinets, pipes, etc. All perimeter expansion areas must be completely filled in with a water-repellent flexible silicone sealant. When applying sealant, it is helpful to first apply a strip of masking tape parallel to and approximately 1/32-inch from the edge of the flooring. Then fill the expansion area with sealant, remove any excess with a plastic scraper or putty knife, then remove the tape. Let dry for 24 hours before exposure to water. It is important that moisture does not enter the core of any cut planks.

WET AREA RECOMMENDATIONS

Special procedures should be followed when installing HF Design laminate floors in areas that are prone to moisture (i.e. bathrooms, powder rooms, kitchens, mud rooms, foyers, and laundry rooms).

- Always install an 8mil (0.2mm) vapor barrier prior to installing the underlay and laminate flooring.
 - Overlap vapor barrier edges by 8" (20cm) and seal with moisture resistant adhesive tape.
 - Run vapor barrier 3/4" (2cm) up wall and trim after wall base is installed.
- Fill all expansion spaces with 100% silicone caulking (caulking is flexible and will still allow HF Design laminate floors to expand and contract.
- The toilet must be removed when installing HF Design laminate floors in bathrooms and a 3/8" (10cm) expansion must be left between the flooring edge and the toilet flange. The expansion space must be filled with 100% silicon caulking.

HF Design laminate flooring is made from wood and excessive exposure to moisture will damage the planks. It is strongly recommended that spills be wiped up immediately.

Pipes

In rows where there is a pipe, make sure the pipe falls exactly in line with the short side of two planks. Take a drill bit with the same diameter as the pipe plus 3/4-inch for the expansion. Click the planks together on the short side and drill a hole centered on the joint between the two planks. Now you can install the planks in the floor. See Diagrams 6A-6B-6C.

Under Doorframes

When sawing the planks, ensure that the expansion joint under the door is at least 3/8-inch. If you cannot lift the plank, use an adapted tapping block or pull bar and hammer to tap the planks together with the planks flat on the floor.

Finishing

Remove all spacers. Install the molding on the plastic membrane that runs up the wall from under the floor. Never attach the molding to the floor. This method allows the floor to expand and contract under the molding.

- For a perfect finish around pipes, use rosettes or flexible silicone sealant.
- In places where profiles or moldings cannot be placed, fill expansion gaps with flexible silicone sealant

REPLACEMENT

Disassembling Panels Near Walls

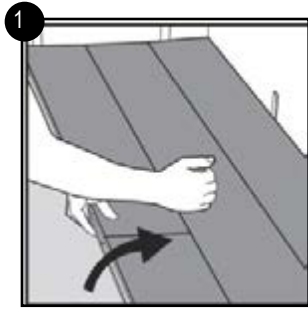

Separate the whole row by carefully lifting up and release the whole row.

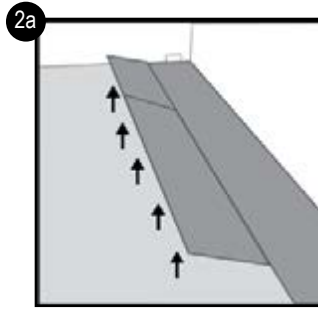

Disassemble the panels by lifting the short ends upward and disengage from the rest.

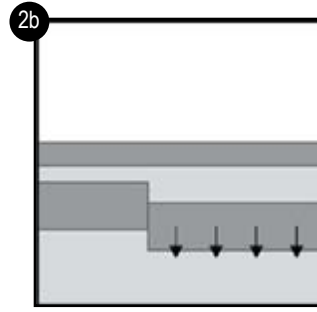

Slide one panel forward. Never fold up a panel, as this damage the profile.

How NOT to Disassemble a Panel

DO NOT lift planks from the center. This will cause damage the groove. Please use the slide method or lift planks from the end joint as shown on the step above.

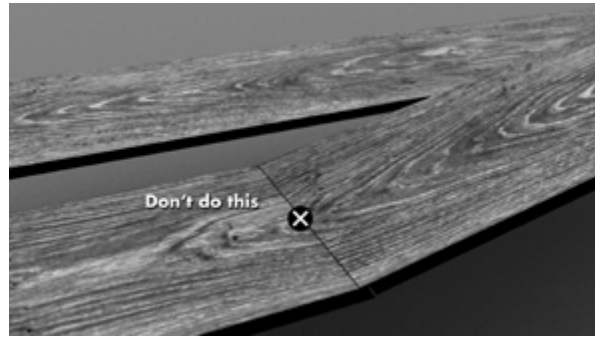

Replacement of a Panel in the Middle of the Room

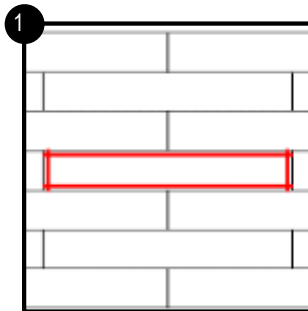

Please cut the panel along the red lines as indicated below.

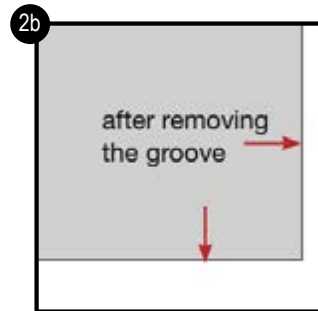
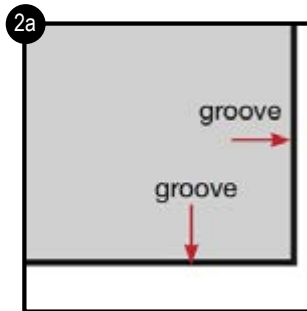

Remove the groove on both sides as indicated in the above pictures.

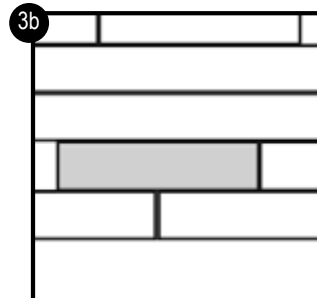
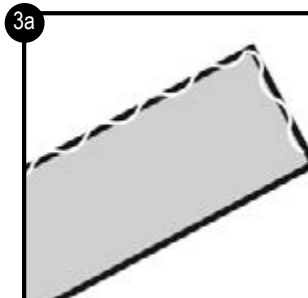

Apply glue on the cut groove side to adhere to the adjacent planks.

CARE & MAINTENANCE

Cleaning

- For general cleaning, use a dust mop or vacuum cleaner with the correct hard surface attachment – never a rotating brush, floor scrubbers, jet mops, buffers or similar products. The floor may be cleaned with a light damp or wet mop / microfiber cloth and an appropriate laminate cleaner.
- Avoid using too much water and never pour the bucket of water / solution across the floor. Be sure to squeeze the water out of the mop before mopping, and rinse the mop frequently.
- **Do not allow for liquid to remain on the floor for longer than 100hours.**
- Remove stains immediately with a well-wrung cloth. Worn-in stains are difficult to remove. Pet stains (including urine, feces and vomit from domestic cats or dogs) need to be cleaned within 24 hours.
- After washing always wipe dry with a micro fiber cloth until no more moisture is visible on the floor and allow your floor the time to dry.
- The use of residential steam mops on this product is allowed. Use at lowest power with a suitable soft pad, and do not hold a steam mop on one spot for an extended period of time (longer than 1 minutes). Refer to the steam mop's manufacturer instructions for proper usage. **NOTE: Excessive steam mopping can damage the floor.**

Removing Stains From Laminate Flooring

Stain:	Remove With:
Rubber marks, Heel Marks, dirt, & Colored Pens/Crayons	Brush off when dry using a nylon pad or cloth.
Beverages (Fruit Juices, Milk, Wine, Soft drinks, etc.)	Immediately wipe down with an absorbent cloth. If already dry, wipe with suitable laminate flooring cleaner.
Urine, Blood	
Felt Pens/Ink, Makeup Show Polish, Paints, Oils, Grease, etc.	Wipe down with a cloth and a small amount of solvent, i.e. acetone, vinegar, nail polish remover, or paint thinner, etc.
Chocolate (and other food stains)	Use a suitable laminate flooring cleaner.

Protecting

- Never use wax on the floor.
- Never use abrasive agents, as those can affect the gloss layer.
- Place small carpets or rugs on high-traffic areas.
- Place doormats at exterior doors, to reduce the amount of dirt coming in.
- Place beige, felt floor protectors under chair and table legs. Do not use colored floor protectors.
- Avoid wearing damaged or worn stiletto heels.
- Place a protective mat under chairs with wheels. Place a protective dish under flowerpots.
- Do not drag heavy objects across the floor; lift them up to avoid scratches.
- Use floor protectors and furniture legs/castors with a large ground surface to limit the impact of heavy objects.
- Maintain a normal indoor relative humidity level between 30% - 60%. Use a humidifier, if necessary.

**STOP! READ!****ATTENTION! READ BEFORE INSTALLING!**

ALL FLOOR COVERINGS SHOULD BE PROFESSIONALLY INSTALLED TO ENSURE A VALID WARRANTY.

We warrant all our products to be free from defects in material and workmanship, under normal use and service, for a specified length of time from the date of purchase as set forth below. This Limited Warranty only applies provided the flooring covered by this warranty is installed and maintained according to our Installation & Maintenance Manual.

WARRANTY COVERAGE AC4

Structural	Residential	Light Commercial
Lifetime	Lifetime	10 Year

LIMITED RESIDENTIAL USE WARRANTY**SCOPE OF APPLICATION**

This Limited Residential use warranty is offered by us and is Worldwide applicable. This warranty applies to our waterproof surface laminate flooring, purchased from authorized dealer and installed and used residentially. Residential use is defined as normal household use.

WARRANTIES**WEAR WARRANTY**

We warrant to the original purchaser that the wear layer on our flooring:

- Will not wear through the decorative surface. Scratches, indentation or reduction in gloss level is not considered wear.
- Will not fade as a result of direct sunlight or normal indoor lighting.
- Will not stain from normal household use.
- In its original manufactured condition, will be free from manufacturing defects.
- Starting from the date of purchase, but only if no exclusions are applicable and only if all conditions are fulfilled.

STRUCTURAL WARRANTY

We warrant the original purchaser that our flooring:

- Will not delaminate.
- In its original manufactured condition, will be free from manufacturing defects.
- Starting from the date of purchase, but only if no exclusions are applicable and only if all conditions are fulfilled.

INSTALLATION OVER A RADIANT-HEATED SUBFLOOR WARRANTY

We warrant to the original purchaser starting from the date of purchase, the floor can be installed over a radiant-heated subfloor, but only if no exclusions are applicable and only if all conditions are fulfilled. This radiant-heated subfloor warranty is only applicable when at least the following cumulative requirements are fulfilled. The radiant heating system has to be a water pipe radiant heating system (this means for example that we do not warrant installation over electrical radiant heating systems). The radiant heating system must incorporate electronic temperature controls. Before installing over newly constructed radiant heat systems, operate the system for 3 weeks at maximum capacity to force any residual moisture from the cementitious topping of the radiant heat system. Then set the thermostat to a comfortable room temperature for the installation. It is recommended that the radiant heat be applied in a gradual manner after installing the flooring. Refer to the radiant heat system's manufacturer recommendations for additional guidance. Maximum operating temperature should never exceed 81°F / 27°C.

PET WARRANTY

We warrant that the floor will resist staining caused by pet (domestic cat or dog) stains, including urine, feces, and vomit. Stain resistance means the ability of your floor to resist (i.e., minimize or withstand) permanent stains for the warranty period. However, accidents should be cleaned up immediately, as the longer they sit, the more difficult they will be to remove. Any damage to the subfloor and/or surrounding structure caused by pets is not covered by this warranty.

RESIDENTIAL WATERPROOF SURFACE FLOORING WARRANTY

When properly installed, the floor will not be damaged by topical, localized spills resulting from normal household use, such as wet shoes, liquid spills, dripping while exiting a bath tub or shower. Flooding is NOT covered by the warranty, which means standing water must be avoided at all times.

LIGHT COMMERCIAL WATERPROOF SURFACE FLOORING WARRANTY

Light commercial use means: use in environments (which do not have heavy commercial traffic) such as outlined in the application table below.

Examples of business type commercial use	Recommended application
Professional offices, Medical offices.	All non-required "clean room" areas – Corridors, patient rooms, lobby, waiting rooms, cafeteria, exam rooms, common areas.
Offices, banks.	Offices, hallways, lobby, reception areas, break rooms, conference rooms.
Boutiques, retail store, art galleries, book-stores, coffee shops, gift shops, jewelery stores, beauty salons, barber shops.	Dressing rooms, entire store.

EXCLUSIONS AND CONDITIONS

- Damage arising by not following relevant installation, care, maintenance and use instructions of the present warranty and the installation instructions provided.
- Damage arising from improper installation (for example installation on an unlevelled subfloor and installation when there is not sufficient perimeter expansion zone), improper care, improper maintenance or improper use.
- Damage arising because the flooring is exposed to extreme cold (below 60°F) or extreme heat (above 85°F).
- Damage arising because the flooring is exposed to low or high humidity not within 30% - 60%:
- Damage caused by exposure to excessive moisture (for example excessive moisture in a concrete slab, excessive moisture from hydrostatic pressure, flooding, standing water, water underneath the flooring, excessive moisture as the result of malfunctioning appliances such as dishwashers, ice makers, refrigerators, sinks, pipes).
- Normal wear and tear of the flooring.
- Normal changes in color, gloss, grain pattern and tone (this is normal for flooring as it ages).
- Damage arising because the flooring is installed in an outdoor area, a solarium, a porch, a garage or areas similar to all of these.
- Damage arising from excessive steam mopping.
- Damage arising from accidents, abuse, misuse, or the use of strong chemicals.

- Damage caused by an act of God (for example a natural disaster).
- Damage caused by vacuum cleaner beater bars or hard plastics, or metal caster wheels.
- Damage caused by wheelchairs.
- Differences in aspect, color, gloss, grain pattern and tone with the reference flooring sample in for example the store or showroom.
- Flooring that has been damaged or neglected during transportation.
- Scratches, marks, stains and other damage caused by exposure to "abrasives" such as pebbles, grit, sand, high heeled shoes, furniture, etc.
- Indentations.
- Damage to click joints or indentation due to heavy rolling loads.
- Damage of planks coming apart at the seams because they have been engaged/disengaged more than three times.
- Damage caused by the collections of dirt and moisture at entrances do due the lack of interior and exterior doormats.
- Damage caused by shoes having heel taps or sharp objects protruding from the sole such as rocks, exposed nails and gravel.
- Damage caused by walking on with spike-or stiletto-heeled shoes.
- Damage caused by sliding or rolling heavy objects on the floor. A solid protective covering must be laid (must use at least 1/4" / 6.35 mm hard board) on your floor and gently "walk" the item across it. Carpet or cardboard is not adequate to prevent surface indentation or roller marks from occurring or scratches to the floor.
- Damage caused by non-compliant casters on furniture. Barrel-type caster wheels or wide, flat glides are best for protecting the floor. For areas with rolling chairs (e.g. desk area), ensure a protective mat is used under the chair.
- Damage caused by hard narrow furniture rollers. They must be replaced with wide rubber rollers.

This warranty is valid only to the original purchaser. It is not transferable and only applicable to the first installation of the flooring. The affected area must be visible and cover an area bigger than 0.04 in² / 25 mm². This warranty does not apply to any products designated as B grade, cabin grades, closeouts, seconds, factory special, non-standard items and flooring sold "as is".

It is the responsibility of the purchaser and the installer, whether they are professionals or a do-it-yourselfers, to inspect all flooring and flooring accessories before installation. If during inspection the purchaser or the installer knows/discovers or can reasonably be supposed to know/discover (for example when the defect is visible), that the flooring has a visible manufacturing issue, do not install the flooring. Please immediately contact the retailer from which the flooring was purchased. No claims will be accepted for flooring of which the purchaser or installer knew/discovered or can reasonably be supposed to have known/discovered, that there was something wrong with it. In such case we only warrant the part of the flooring which has not been installed yet.

We do not allow or authorize any other person or entity to alter the obligations and limitations in this warranty. This warranty is the complete and exclusive expression of our warranty and is in lieu of all other express and/or statutory warranties. Any implied warranties, including but not limited to the implied warranties, merchantability and fitness for a particular purpose are limited to this express warranty. However, some jurisdictions do not allow exclusion or limitation on how an implied warranty lasts, so the above limitation or exclusion may not apply to you.

We expressly exclude and will not pay consequential or incidental damages under this warranty. By this we mean for example loss, expense, inconvenience or damages, other than to the flooring itself, that may result from a defect in the flooring. However, some jurisdictions do not allow exclusion or limitation of incidental or consequential damages, so the above limitation or exclusion may not apply to you.

We reserve the right to inspect the flooring and to remove samples for additional evaluation, if we consider this necessary. Any attempt to repair or replace the flooring without our consent will void this warranty. The failure of either party to enforce any of the provisions of this warranty agreement shall not be construed as a waiver of such provision or a waiver of the right of any party thereafter to enforce each and every provision. This warranty gives you specific legal rights and you may also

have other rights which vary from jurisdiction to jurisdiction. We will always respect these other rights. No implied warranties extend beyond the term of this written warranty.

WHAT YOU SHOULD DO IF ANY OF THE ABOVE LISTED PROBLEMS OCCUR

You should notify the original dealer of the defect within 30 calendar days after you know/discover the defect and within the validity period of this warranty. Your dealer can answer your questions and, if necessary, start to process a claim. If your notification takes place outside this period, our warranty will not be applicable. In order to enjoy the warranty, you are obligated to present:

- A valid proof of purchase in the form of the sales receipt for the flooring and other accessories related to the installation which may affect the installation quality such as but not limited to adhesive, molding, underlay, moisture barrier, molding, etc.
- A detailed description of the defect and/or a photograph or sample of the flooring that clearly shows the defect. Provide additional information requested by the factory to understand the root cause of the issue.